

TRANSECT-TRAIL OPENING BIOMONITORING PROTOCOL

Participatory Biodiversity Monitoring: Setting out Transects
BARAM HERITAGE SURVEY INITIATIVE
2019-2021

METHODS : Fragoso J.M.V., K.M. Silvius, J.N. Strong, J.M. Read, J.P. Gibbs e L. F. B. de Oliveira. 2011. Delineando um programa de Monitoramento Animal usando transecções, Stanford university, Stanford, CA, EUA

Ilustrações: Equipe de Conservação da Amazônia

Agosto 2012

Trails-Transects For Project

Opened trails will be used to search for animals by indigenous researchers chosen by the community during the Project. TRAILS MAY NOT BE USED FOR HUNTING but hunters can hunt around area of trails, as per usual habits but cannot walk on transects.

- a) Trail size: Each track will be 4Km (4,000 meters)

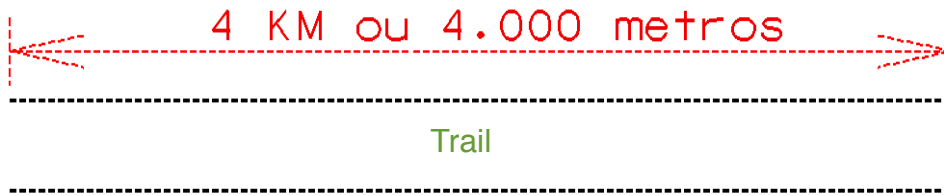

- b) Trail width: The width of each track will be 1 meter



- c) Trail with big tree in the middle: No need to cut down just open trail after it

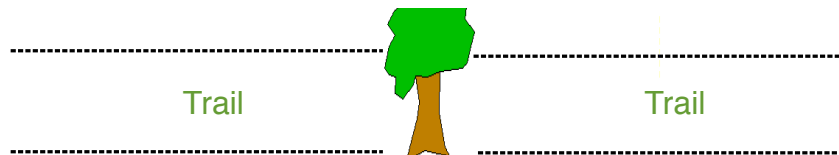

- d) Trail with very high mountain: If you have a mountain that you cannot climb, go back and continue opening the trail to the other side.

FIRST THING TO DO IF YOU HAVE MOUNTAIN

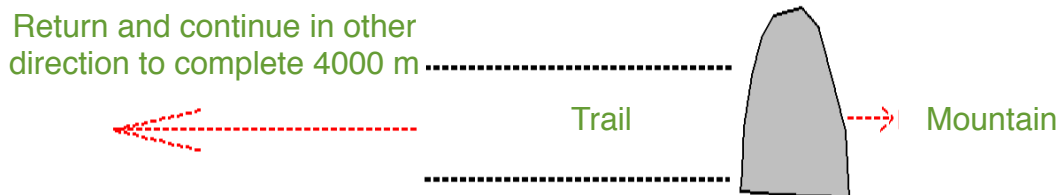

SECOND OPTION IF YOU ENCOUNTER IMPASSABLE MOUNTAIN

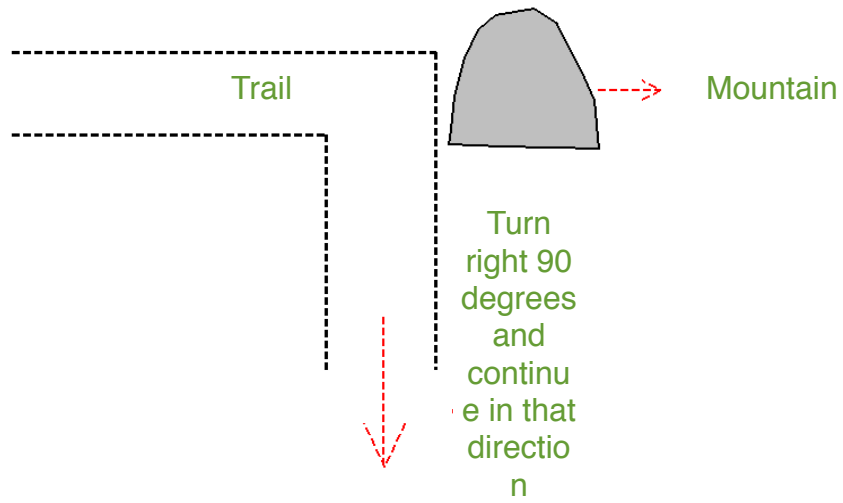

Or

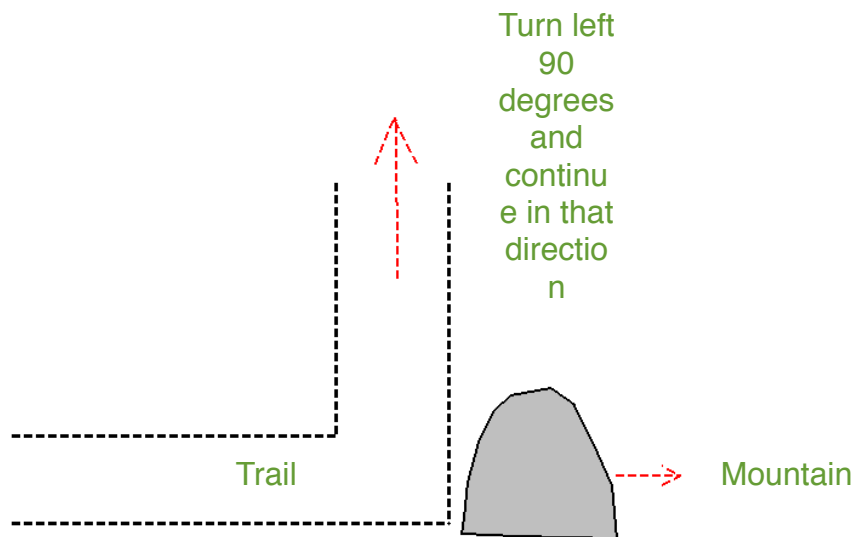

- e) Trail with stream in the middle: Continue the trail on the other side of the stream.

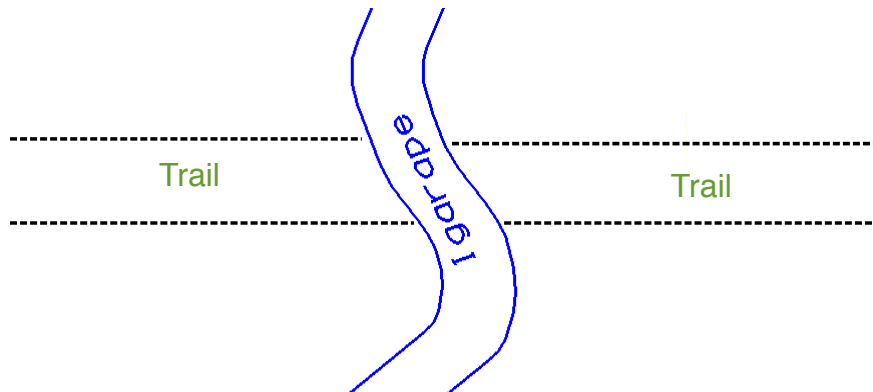

- f) Trail with lake in the middle: Continue the trail in the other direction

FIRST THING TO DO IF YOU HAVE LAKE

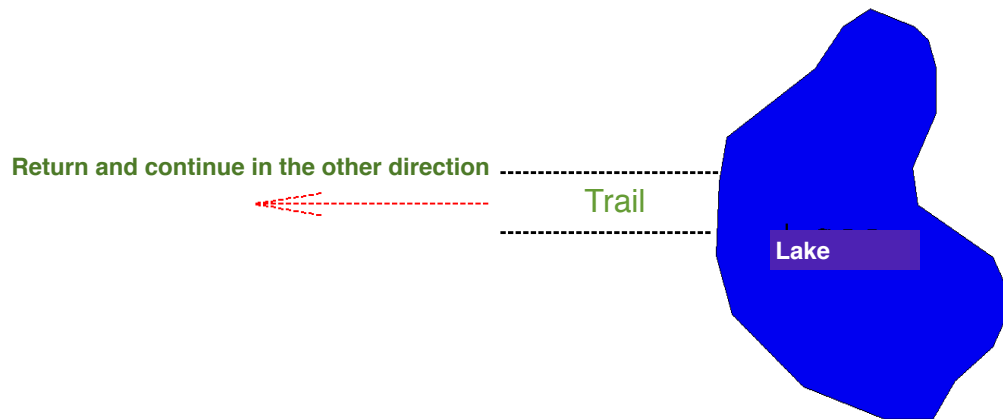

SECOND OPTION IF YOU ENCOUNTER A LAKE

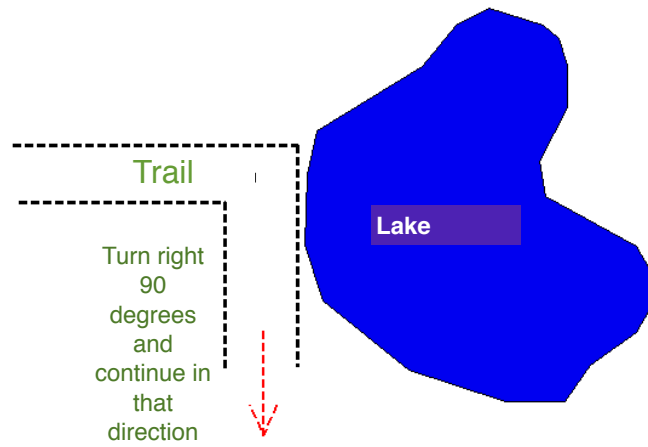

THIRD OPTION IF YOU ENCOUNTER A LAKE

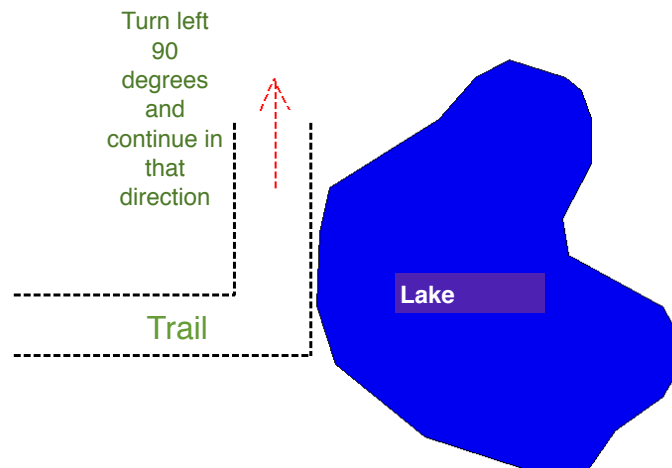

g) Trail-Transect Marking: Mark the trail with 2 m tall poles every 50 meters, starting from 0 to 4Km (4000 meters).

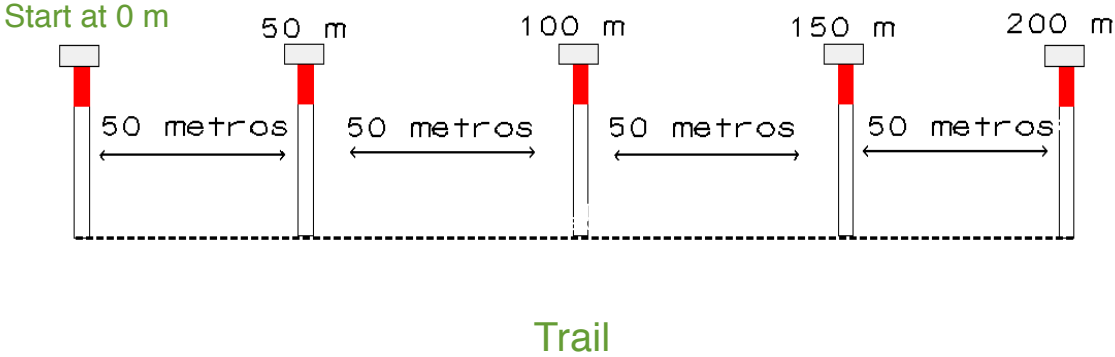

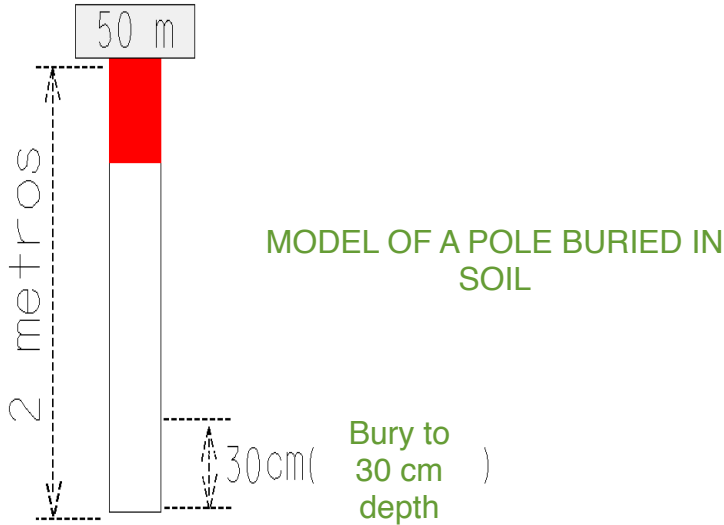

1. LEARNING TO USE THE GPS UNIT



2. BUTTONS ON THE GPS



Botão de Ligar/Desligar

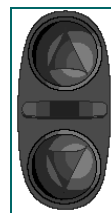

Para cima

Para baixo



Botão de Página



Botão Enter

3. PAGES ON THE GPS

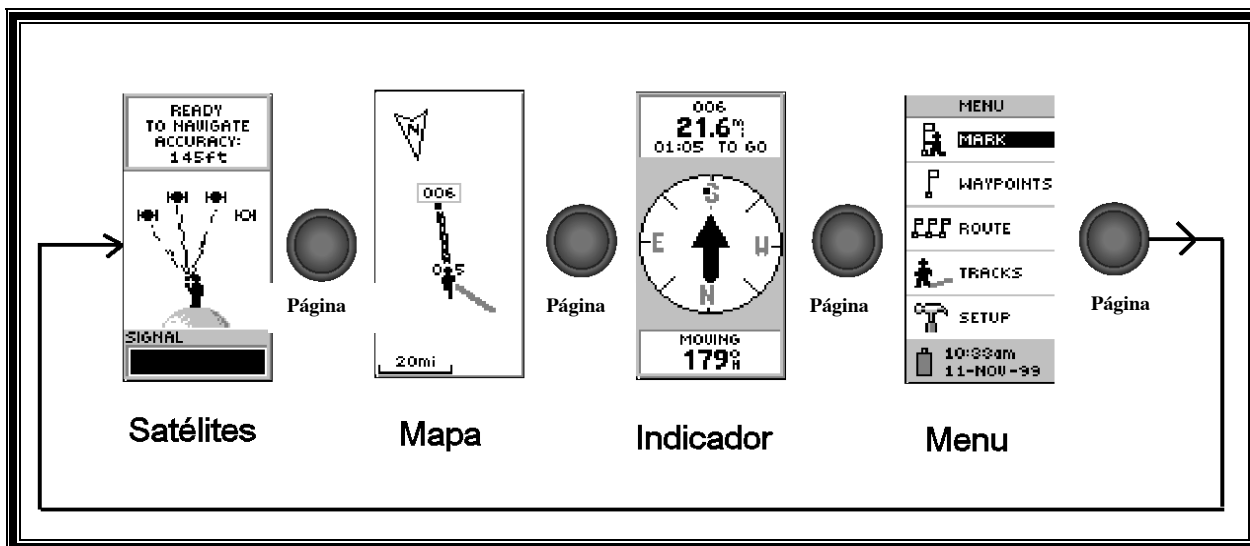

3. RECORDING A LOCATION

3.1 - Para ligar apertar e segurar o **BOTÃO LIGAR** até aparecer a página abaixo (e) para desligar fazer a mesma coisa

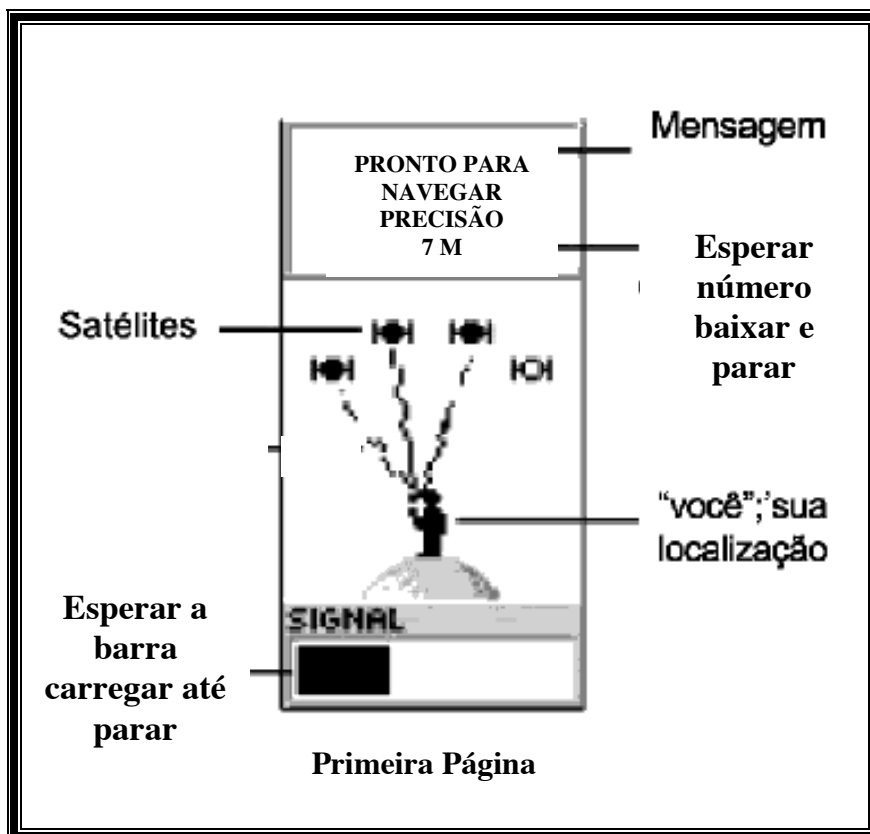

3.2 - Apertar o **BOTÃO PÁGINA** até aparecer a página que está abaixo, descer até **MARCA** e apertar o **BOTÃO ENTER**.

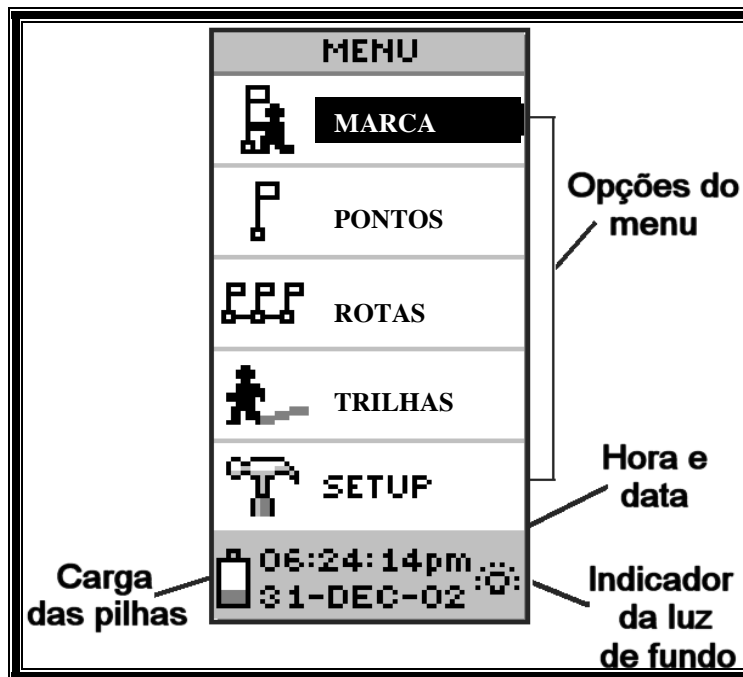

3.4 - Logo em seguida aparecerá a página que está abaixo, para mudar o símbolo, ir com o **BOTÃO PARA CIMA** até o símbolo, apertar o **BOTÃO ENTER**, escolha o símbolo e aperte o **BOTÃO ENTER** novamente e voltará para a mesma página.

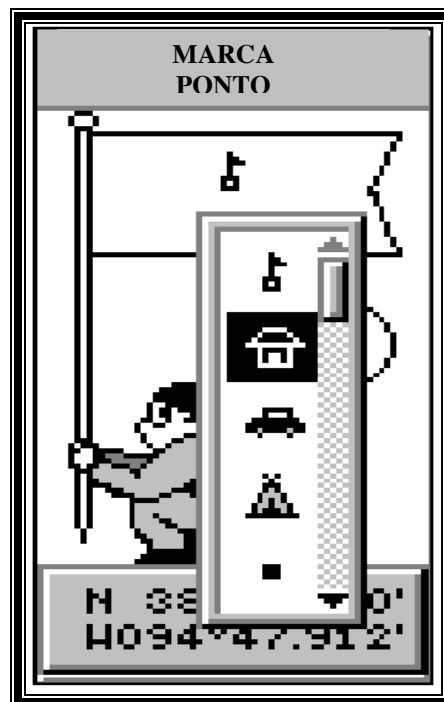

3.5 - Para mudar o nome do ponto, ir com o **BOTÃO PARA BAIXO** até o nome do ponto e apertar o **BOTÃO ENTER**, escolher a letra ou número e apertar o **BOTÃO ENTER** novamente, quando acabar de escolher as letras ir até **OK** apertar **BOTÃO ENTER**.

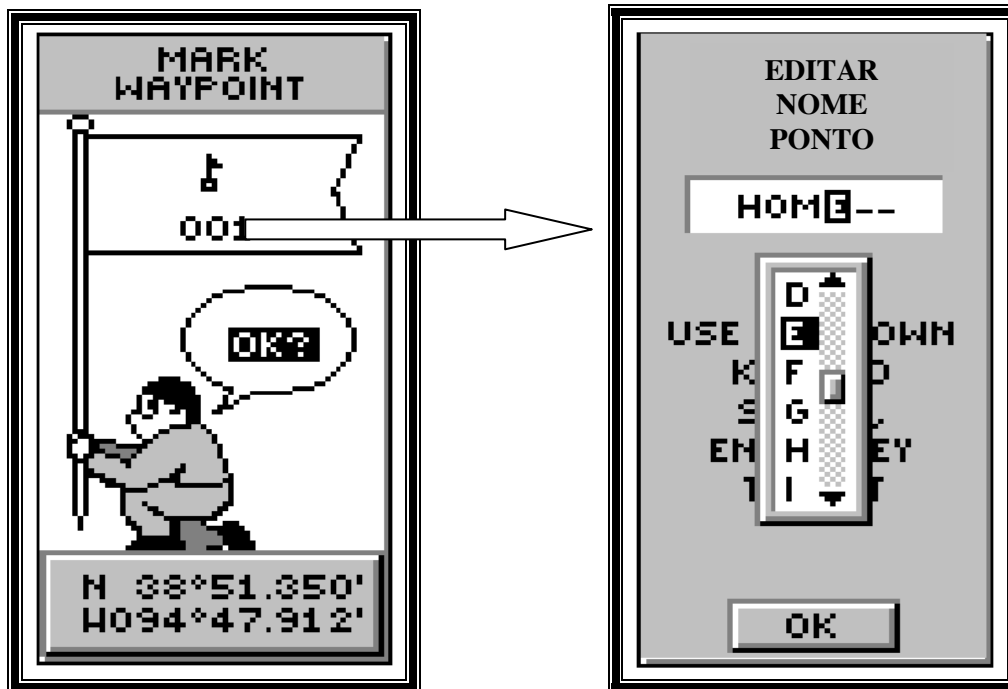

3.3 - Para salvar (guardar) o ponto, ir até **OK** e apertar o **BOTÃO ENTER** até voltar para a página **MENU** novamente.

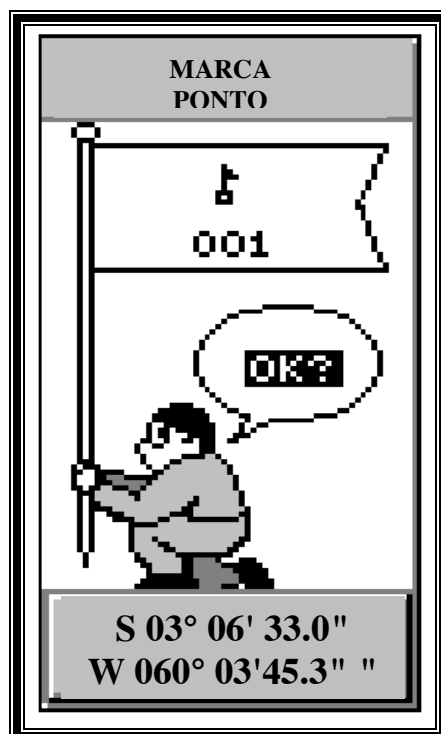

4. COMO CHEGAR AO PONTO USANDO O GPS

4.1 - Apertar o **BOTÃO PÁGINA** até aparecer a página abaixo, com o **BOTÃO PARA BAIXO**, ir até **PONTOS** e apertar o **BOTÃO ENTER**.

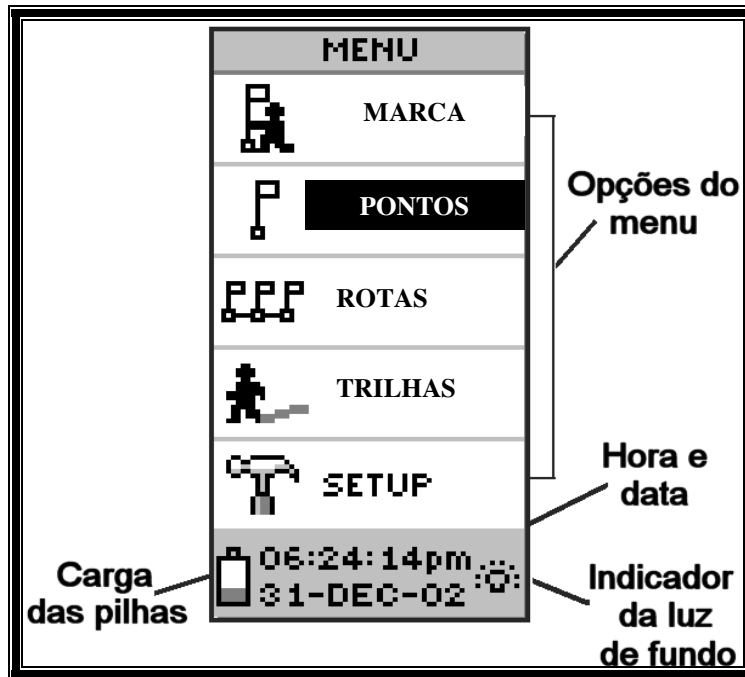

4.2 - Logo em seguida, aparecerá a página abaixo, com o **BOTÃO PARA BAIXO**, marcar a pasta que está salva o ponto e apertar o **BOTÃO ENTER**, depois escolher o ponto pelo seu nome e apertar o **BOTÃO ENTER**

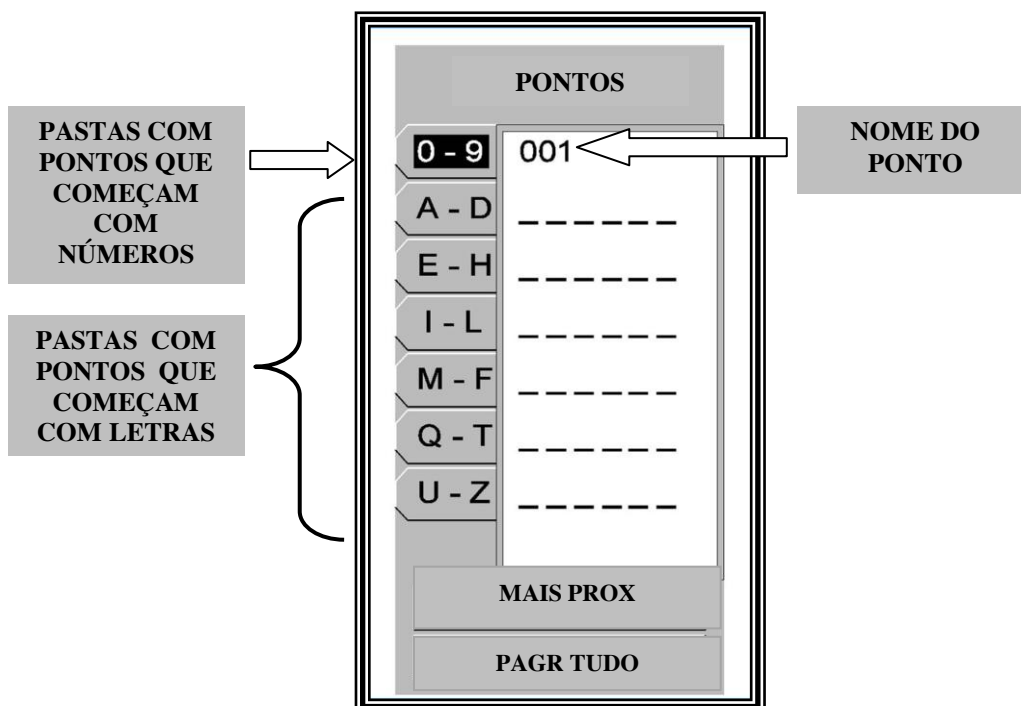

4.3 - Depois que escolher o ponto, aperte o **BOTÃO ENTER** e irá aparecer a página abaixo, verificar o nome do ponto se é o escolhido, ir até **IR PARA** e apertar o **BOTÃO ENTER**.

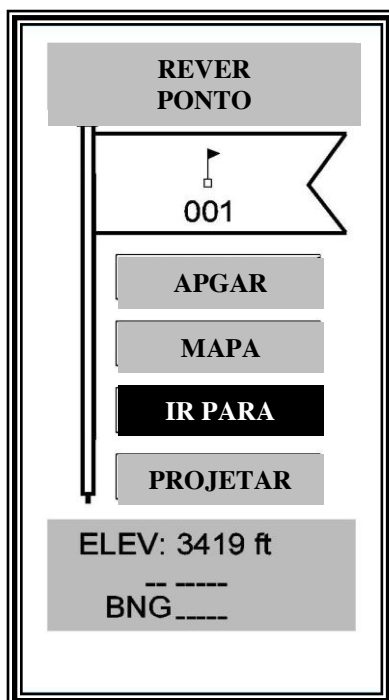

4.4 - Logo em seguida aparecerá a página abaixo, verificar o nome do ponto se é o escolhido e seguir até o local indicado pela seta do GPS.

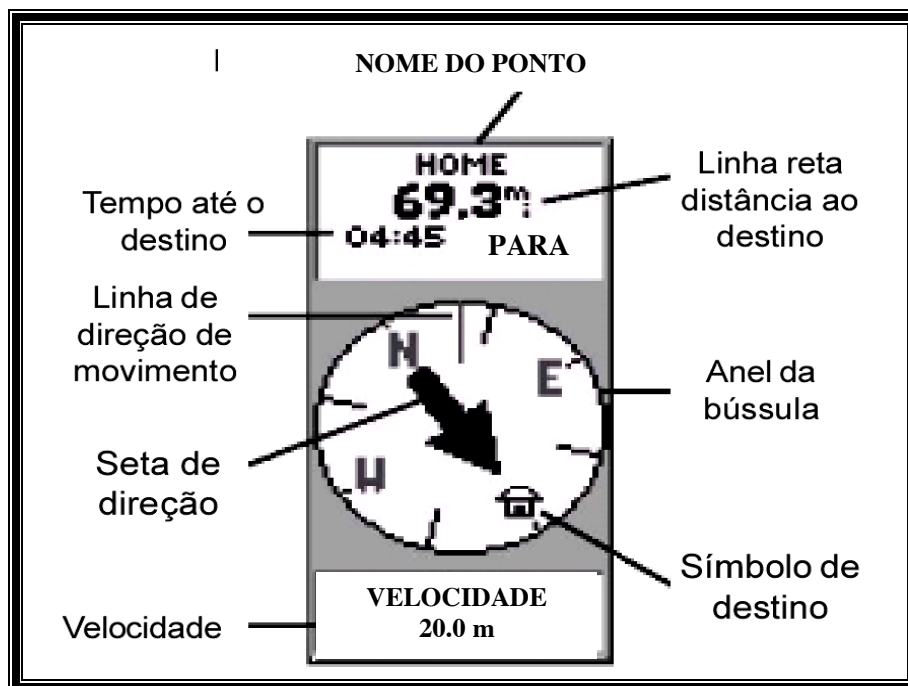

4.5 - Depois que chegar ao ponto escolhido, apertar o **BOTÃO ENTER** irá aparecer a página abaixo, marcar **PARAR NAVEGAÇÃO** e apertar o **BOTÃO ENTER**.



4.6 - Logo em seguida aparecerá a página abaixo, mostrando que parou a navegação.

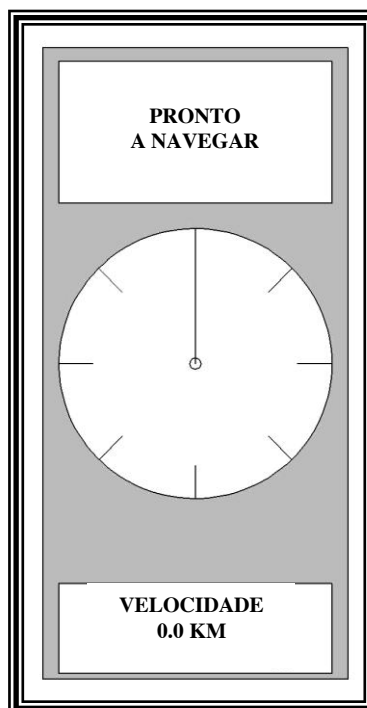

5. USING THE COMPASS



5.1 - The compass is used to indicate directions.

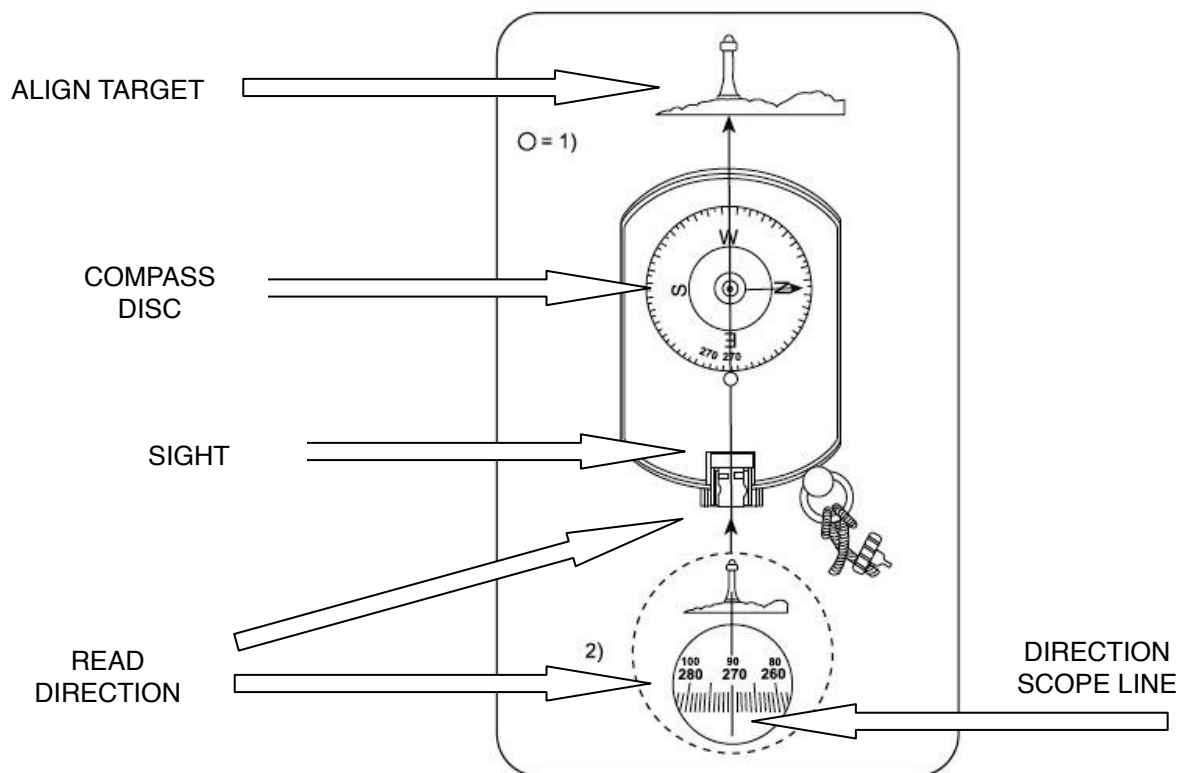

5.2 - How to determine the direction of the target

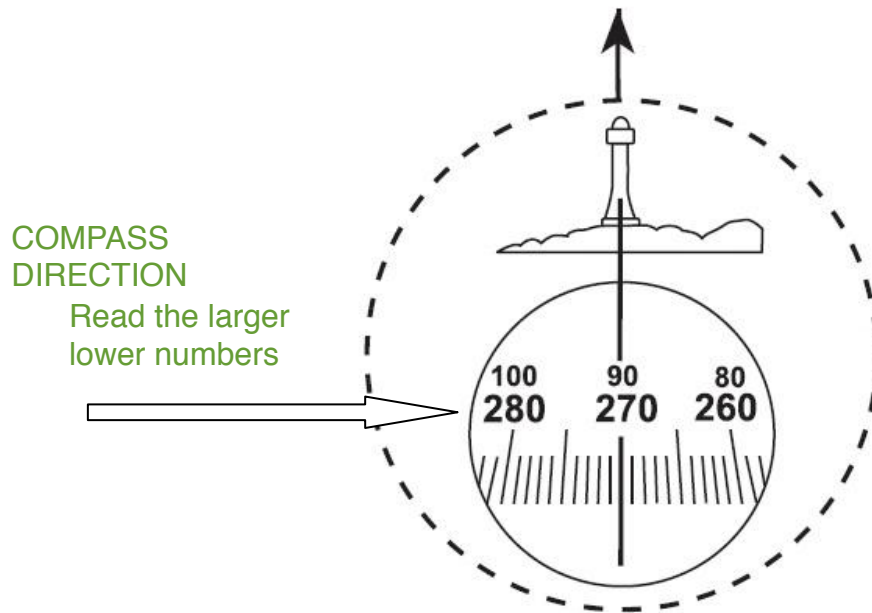

5.2.1 - Direction should always be read from LOW NUMBER by summing each shorter line to the left to the direction line.

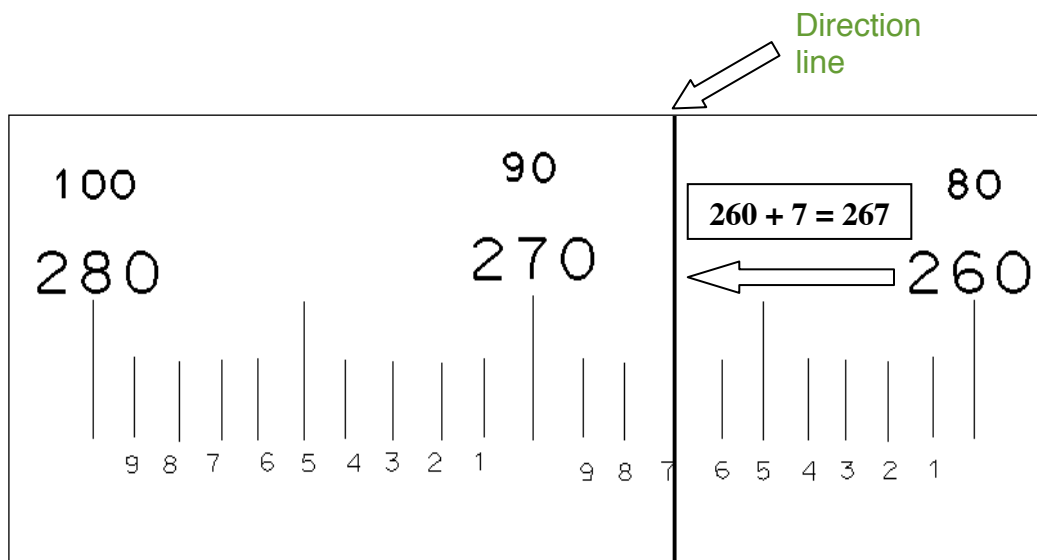

$260 + 7 = 267$ Correct Angle (direction)

Transferring the bearing direction from the map to the compass

- READ THE COMPASS DIRECTION PROVIDED ON THE MAP.
- AIM COMPASS AT TARGET
- LOOK AT DIRECTION READING
- BALANCE (FLAT) THE COMPASS SO THE ROTATING WHEEL IS FREE.
- ROTATE THE COMPASS UNTIL BEARING APPEARS UNDER LINE.

How to find the start of a trail-transect and its direction

- a) Check the map and see if you know the location where the trail-transect is to begin, using the names and shapes of rivers, mountains and ridges. If you know the site turn on the GPS only when you walk near the location;
- b) If you do not know the location, Use GPS to find the beginning of transect by looking for its name as the beginning point of the track in GPS and then ask it to take you there.
- c) Arriving at the beginning of the transect start point using the GPS, aim the transect direction on the compass from the start opening and begin opening/walking the transect. Always use the compass to sight your direction so that the track is always straight;
- d) The trail will be 01 (one) meter wide;
- e) Place the poles with the aluminum tags marking every 50 meters, to the end at 4000 meters.
metros.
- f) Check if there is any impassable barrier in the middle of the trail such as big trees, streams, lakes and mountains and follow the instructions as above of this booklet;

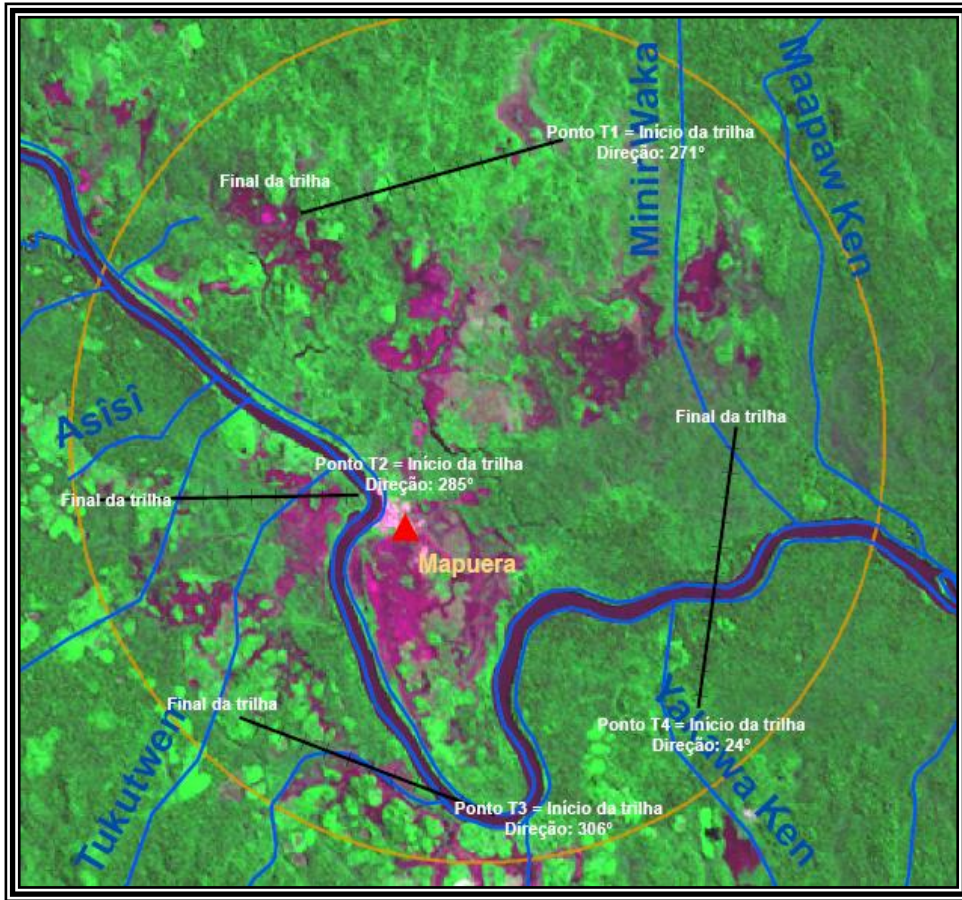

a) Example: map 02